

A

B

C

D

E

1

1

2

2

3

3

4

4

5

5

6

6

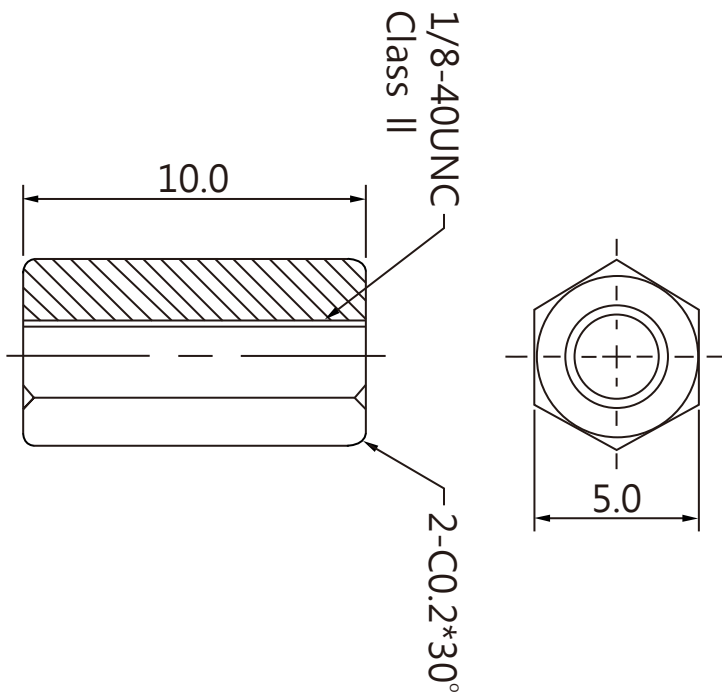

大廣有限公司 DA KOANG CO., LTD.

DATE

DWN

CHKD

APVD

MANAGER

12.08.2005

PART NAME: SCREW NUT

PART NUMBER: 3158

VERSION:2.0

TOLERANCE :±0.3mm UNLESS OTHERWISE SPECIFIED

UNIT:mm



SCALE:

A

B

C

D

E

7

7